

FNI MPL-332-105-M

IP 67 Module User Manual



1 Notes	
1.1. Manual structure	3
1.2. Typography	3
1.3. Symbol	3
1.4. Abbreviations	3
1.5. Visual Bias	3
2 Security	
2.1. Intended use	4
2.2. Installation and startup	4
2.3. General Security Notes	4
2.4. Resistance to Corrosive Substances	4
3 Getting Started Guide	
3.1. Module overview	5
3.2. Mechanical connection	6
3.3. Electrical connection	6
4 Technical data	
4.1. Size	8
4.2. Mechanical data	8
4.3. Operating conditions	8
4.4. Electrical data	8
4.5. Network Port	8
4.6. Function indicator	9
5 Integration	
5.1 Module configuration	13
5.2 Data Mapping	14
5.3 PLC Integration Tutorial	16
6 Appendix	21

- 1.1. Manual structure** This manual is organized by organization, so the chapters are interconnected. Section 2: Basic Safety Information.
Chapter 3: Getting Started Guide
Chapter 4: Technical data
.....
- 1.2. Typography** The following typographic conventions are used in this manual.
- Enumerate** The enumeration is displayed as a list with bullets.
·Entry1
·Entry2
- Action** Action descriptions are represented by a front triangle.
The result of the action is represented by an arrow.
Action description 1
Action result
Action description 2
Step programs can also be displayed numerically in parentheses.
(1) Step 1
(2) Step 2
- Grammar** Number:
Decimal numbers are displayed without additional indicators (eg 123)
Hexadecimal numbers are displayed with an additional indicator hex (eg: 00hex)
or with the prefix
"0X" (eg: 0x00)
- Cross-reference** Cross-references indicate where to find additional information on this topic.

- 1.3. Symbols**
- Notes**
This symbol indicates a general comment.

- Notice!**
This symbol indicates the most important safety notice.

- 1.4. Acronym**
- FNI FAS Network Interface
I Standard input port
PN Profinet
ECT EtherCAT
CIE CC_link IEF Basic
EIP Ethernet/IP
EMC Electromagnetic Compatibility
FE functional ground
O Standard output port
- 1.5. Viewing deviations** The product views and explanations in this manual may deviate from the actual product. They are only left and right solutions



Explain the materials used.

2 safety

2.1. Expected usage This manual describes as decentralized input and output modules for connection to an industrial network.

Precautions!

2.2. Install and start Installation and start-up may only be carried out by trained and specialized personnel. A qualified individual is one who is familiar with the installation and operation of the product and has the necessary qualifications to do so. Any damage caused by unauthorized operation or illegal and improper use is not covered by the manufacturer's warranty. Equipment operators are responsible for ensuring that appropriate safety and accident prevention regulations are followed.

2.3. General security Notes Debug and check Before debugging, you should read the contents of the user manual carefully.

The system cannot be used in applications where the safety of personnel depends on the functionality of the equipment. intended use

The manufacturer's warranty coverage and limited liability statement do not cover damage caused by:

- Unauthorized tampering
• Improper use
• Owner/operator's obligations

This device is an EMC Class A product. This device generates RF noise.

The owner/operator must take proper precautions when using this equipment. Use only a power source compatible with this device and connect only approved cables.

Fault

In the event of a defect or equipment malfunction that cannot be corrected, the equipment must be taken out of operation to avoid possible damage from unauthorized use.

Intended use can only be ensured when the enclosure is fully installed.

2.4. Corrosion resistance

Precautions!

FNI modules generally have good chemical and oil resistance characteristics. When used in aggressive media (e.g. high concentrations of chemicals, oils, lubricants and coolants (i.e. low water content)), these media must be checked before the corresponding application material compatibility confirm. If the module fails or is damaged due to this corrosive medium, no claim for defects can be claimed.

Dangerous voltage

Precautions!

Disconnect all power sources before using the equipment!

3. Getting Started Guide

3.1. Module overview

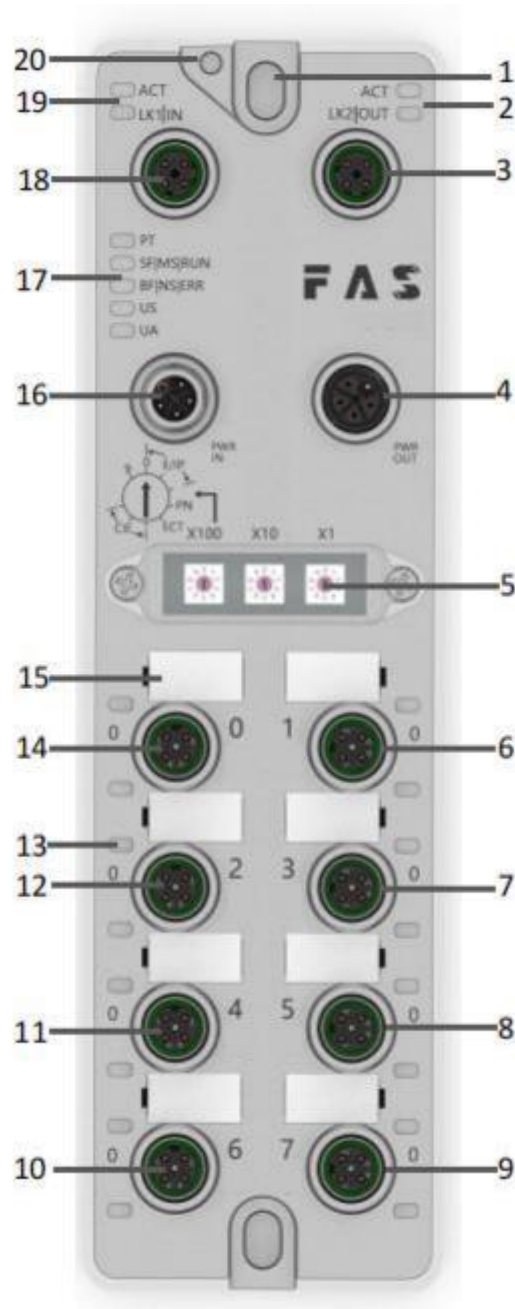

- | | | |
|-----------------------------------|---------------------------|------------------------------------|
| 1 Mounting hole | 8 Port 5 | 15 Port Identification Board |
| 2 Network port 2 Status indicator | 9 Port 7 | 16 Power input port |
| 3 Network port 2 | 10 Port 6 | 17 Module indicator |
| 4 Power outlet | 11 Port 4 | 18 Network port 1 |
| 5 DIP switch | 12 Port 2 | 19 Network port 1 status indicator |
| 6 Port 1 | 13 Port Status Indicators | 20 Ground connection |
| 7 Port 3 | 14 Port 0 | |

3. Getting Started Guide

3.2. Mechanical connection The modules are attached using 2 M6 bolts and 2 washers. Isolation pads are available as accessories.

3.3. Electrical connections

3.3.1 Power interface(L-code)

Definition of power input port Definition of power outlet

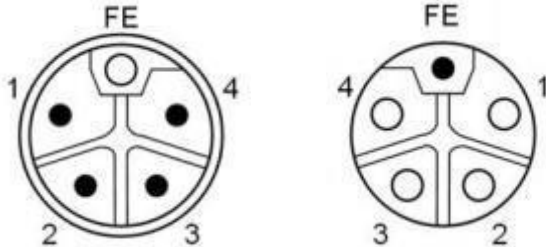

Pin	Function	Describe
1	Us+	+24V
2	Ua-*	0V
3	Us-	0V
4	Ua+*	+24V
FE	Functional ground*	FE

Notes:

1. If possible, supply sensor/module power and actuator power separately.Total current <9A. The total current of all modules is <9A, even when daisy-chaining the actuator power supply. 2. The FE connection from the housing to the machine must be low impedance and kept as short as possible.3.3.2 Network Interface (D-code)

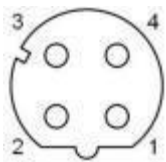

Pin	Function	
1	Tx+	Send data+
2	Rx+	Receive data+
3	Tx-	Send data-
4	Rx-	Receive data-

Notes:

Unused I/O port sockets must be covered with end caps to meet IP67 rating.

3.3.3 I/O-Port(A-code)

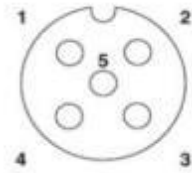

Pin	Function
1	+24V,1A
2	Enter/output
3	0V
4	Enter/output
5	FE

1. For digital sensor input, please follow the input guidelines of EN61131-2, Type 2.
2. The maximum output current of pins 2 and 4 is 2A. The total current of the module is less than 9A.
3. Unused I/O port sockets must be covered with end caps to meet IP67 degree of protection.-

4. Technical data

4.1. size

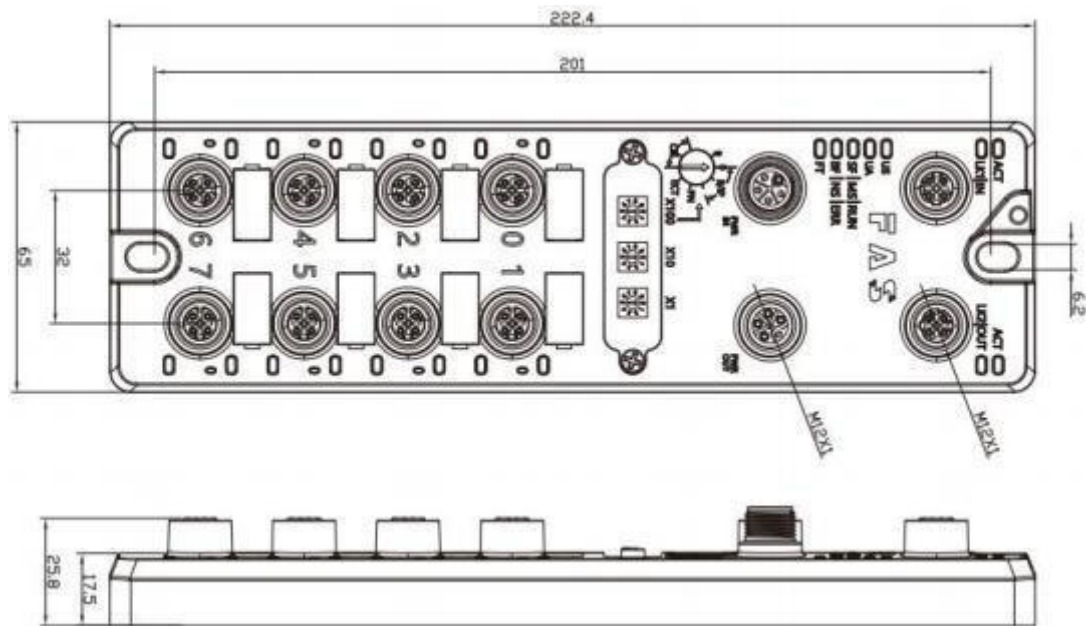

4.2 Mechanical data

Shell material	Die-cast aluminum case, pearl nickel plated
Housing class according to IEC 60529	IP67 (only in plug-in or plug-in style)
Power interface	L-Code (Male and Female)
Input port/output port	M12, A-Code (8*female)
Size(W*H*D)	65mm*222mm*25.8mm
Installation type	2-Through Hole Mounting
Ground Bus Accessories	M4
weight	About 670g

4.3. Operating conditions

Operating temperature	-5°C ~ 70°C
Storage temperature	-25°C ~ 70°C

4.4. Electrical data

Voltage	18~30V DC, Symbol EN61131-2
Voltage fluctuation	<1%
Input current at supply voltage 24V	<130mA

4.5 Network port

Port	2 x 10Base-/100Base-Tx
Port connection	M12 , D-Code
IEEE 802.3 Compliant Cable Types	Shielded twisted pair, min. STP CAT 5/STP CAT 5e
Data transfer rate	10/100 M bit/s
Maximum cable length	100m
Flow control	Half condition/full condition(IEEE 802.3-PAUSE)

4.6 Function indicator

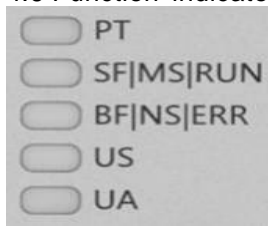

PT	Green	EtherNet/IP communication protocol
	Yellow	ProfiNet communication protocol
	Blue	EtherCat communication protocol
	White	CC-Link IEFIELD basic communication protocol

ECT Communication Protocol Module Status

LED	State	Function
US	Green	Power is OK
	Red	Greater than 30V or less than 11V
	Flashing red	less than 18V
UA	Green	Power is OK
	Red	Greater than 30V or less than 11V
	Flashing red	less than 18V
SF/MS/RUN	Closure	No error, device initialization
	Green light flashing	Pre-operational: The device is in a pre-operational state
	2.5Hz	Safe Operation: The device is in safe operation
	Green light flashes 1HZ	Running: The device is running
BF/NS/ERR	Steady green	No errors, device EtherCAT communication is working
	Closure	Invalid configuration
	Red light flashes 2.5HZ	local error
	Red light flashes 1HZ	Application watch timeout

EIP communication protocol module status

LED	Show	Function
SF/MS/RUN	Green light is always on	Working status: The device is running normally
	Green light flashes 1HZ	Standby: Device not configured
	Green, red and green flashing alternately	Self-test: The device is undergoing a power-on test.
	Flashing red 1HZ	Recoverable failures:
	Steady red light	Unrecoverable failure
	Closure	US no input voltage
BF/NS/ERR	Green light is always on	Connected
	Green light flashes 1HZ	Not connected:
	Green and red off flashing alternately	Self-test: The device is undergoing a power-on test.
	Red light flashes 1HZ	Connection timed out
	Steady red light	IP Duplicate:
	Closure	US No input voltage or no IP address
US	Green	Input voltage is normal
	Flashing red	Low input voltage (< 18 V)
UA	Green	The output voltage is normal
	Flashing red	Low output voltage (< 18 V)
	Red always on	No output voltage present (< 11 V)

PN communication protocol module status

LED	Show	Function
SF/MS/RUN	Closure	Works fine
	Red flashing 3s 1HZ	Bus start
	Red always on	System error
BF/NS/ERR	Closure	Works fine
	Flashing red 2HZ	No data exchange
	Red always on	No configuration; or slow physical link; or no physical link
US	Green	Input voltage is normal
	Flashing red	Low input voltage (< 18 V)
UA	Green	The output voltage is normal
	Flashing red	Low output voltage (< 18 V)
	Red always on	No output voltage present (< 11 V)

CIE communication protocol module status

LED	Show	Function
SF/MS/RUN	Green light off	Module not connected
	Green light flashing 2.5HZ	Module not communicating
	Green light flashes 1HZ	Module is not configured
	Steady green	Running: The device is running
BF/NS/ERR	Closure	Module works fine
	Steady red light	Communication error
US	Green	Input voltage is normal
	Flashing red	Low input voltage (< 18 V)
UA	Green	The output voltage is normal
	Flashing red	Low output voltage (< 18 V)
	Red always on	No output voltage present (< 11 V)

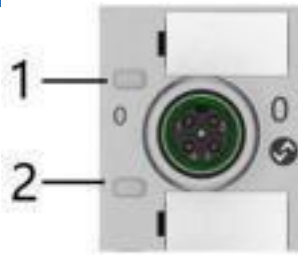

I/O port status

LED	State	Function
1	Closure	The status of Pin4 input or output is 0
1	Yellow	The status of Pin4 input or output is 1
1	Red	Port configured as input: short between Pin1 and 3
1	Flashing red	Port configured as output: Pin4 overcurrent
2	Closure	Port configured as output: short circuit between Pin1 and 3
2	Yellow	The status of Pin2 input or output is 0
2	Rred	The state of Pin2 input or output is 1
2	Flashing red	Port configured as input: short between Pin1 and 3

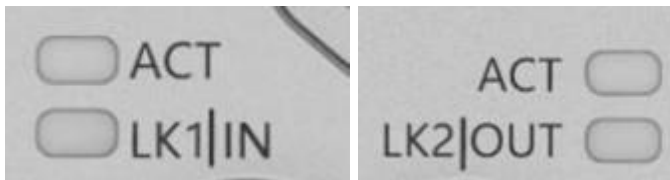

Network port status

LED	State	Function
ACT	Closure	Bus rate: 10Mbit/s
	Yellow	Bus rate: 100Mbit/s
LK1 IN (ECT IN)	Flashing green	Data transmission
LK2 IN (ECT OUT)	Flashing green	Data transmission

5 Integrated
 5.1 Module configuration
 5.1.1 Factory reset and communication protocol switching

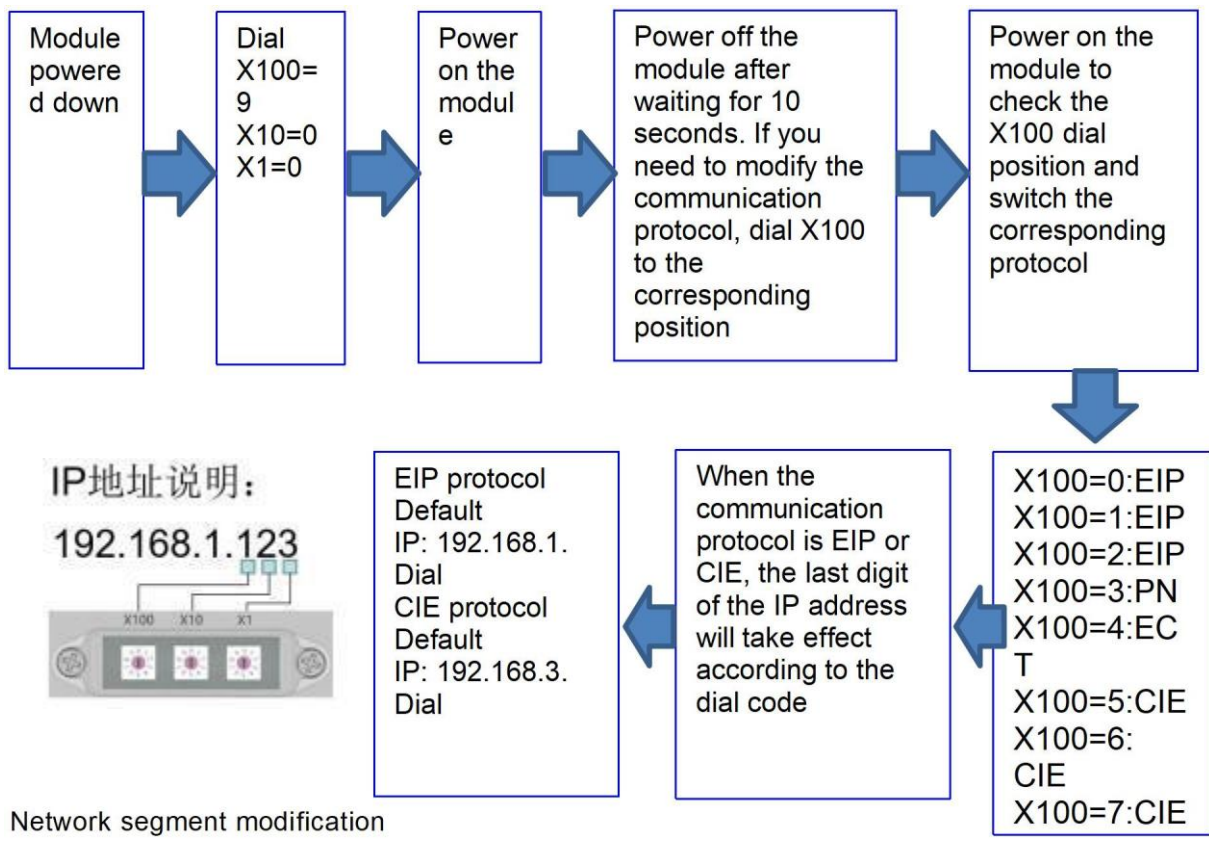

5.1.2 Network segment modification

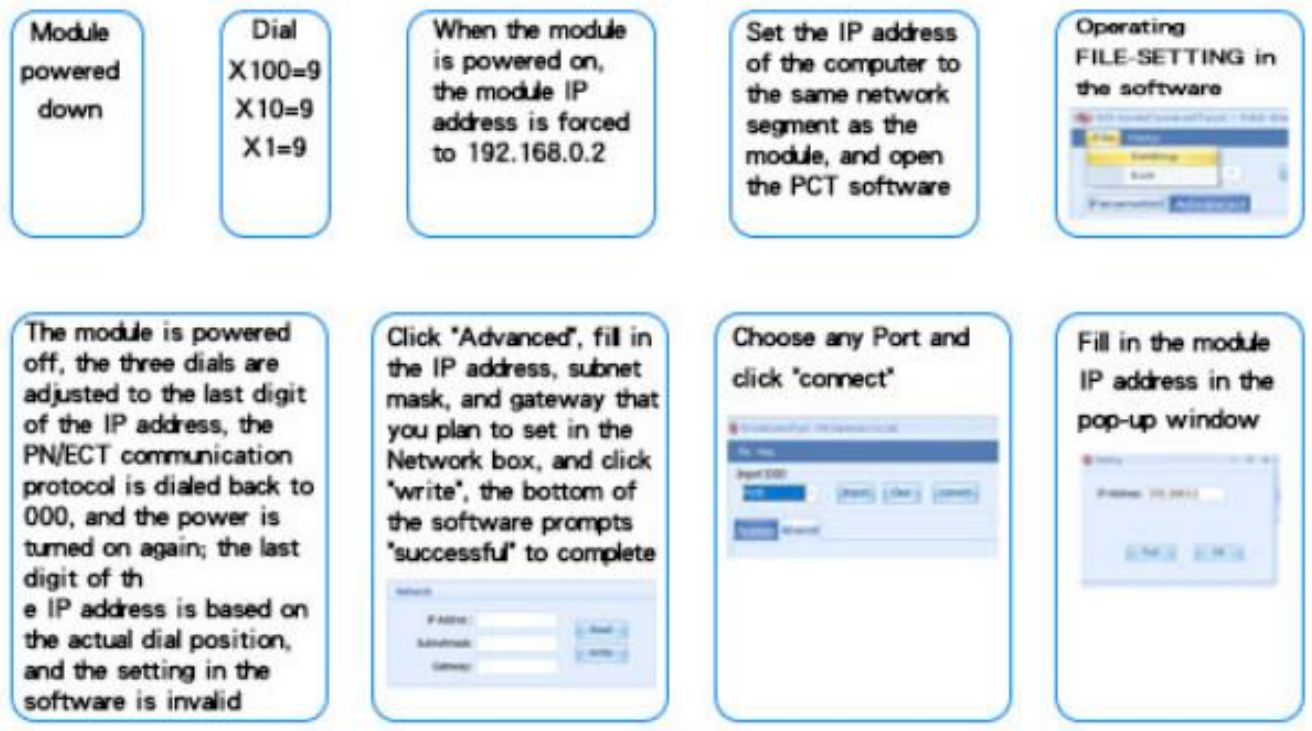

5.2 Data mapping

EIP PN ECT Communication protocol---process output data									
Bytes	Function	位 (Bit)							
		7	6	5	4	3	2	1	0
0	PIN4 output	Port7	Port6	Port5	Port4	Port3	Port2	Port1	Port0
1	PIN2 output	Port7	Port6	Port5	Port4	Port3	Port2	Port1	Port0
Data description (binary): 0=off 1=on									
EIP PN ECT Communication protocol---process input data									
Bytes	Function	位 (Bit)							
		7	6	5	4	3	2	1	0
0	PIN4 input	Port7	Port6	Port5	Port4	Port3	Port2	Port1	Port0
1	PIN2 input	Port7	Port6	Port5	Port4	Port3	Port2	Port1	Port0
2	PIN4 short circuit status	Port7	Port6	Port5	Port4	Port3	Port2	Port1	Port0
3	PIN2 short circuit status	Port7	Port6	Port5	Port4	Port3	Port2	Port1	Port0
4	Port power short circuit	Port7	Port6	Port5	Port4	Port3	Port2	Port1	Port0
5	Module status				Us over voltage	Ua over voltage	overheat	Us undervoltage	Ua undervoltage
Data description (binary): 0=no signal 1=signal									
EIP Communication Protocol---Port Configuration									
Bytes	Function	位 (Bit)							
		7	6	5	4	3	2	1	0
0	PIN4 model	Port3		Port2		Port1		Port0	
1	PIN4 model	Port7		Port6		Port5		Port4	
2	PIN2 model	Port3		Port2		Port1		Port0	
3	PIN2 model	Port7		Port6		Port5		Port4	
Data description (binary): 00 = normally open input 01 = normally closed input 10 = output 11 = input and output adaptive									

EIP communication protocol---port configuration

4	PIN4 Security Mode	Port3	Port2	Port1	Port0
5	PIN4 Security Mode	Port7	Port6	Port5	Port4
6	PIN2 Security Mode	Port3	Port2	Port1	Port0
7	PIN2 Security Mode	Port7	Port6	Port5	Port4

(On network outage) Safe Mode Configuration: 00 = Hold at 0 01 = Hold at 1 10 = Hold at last value

CIE communication protocol---process output data

Bytes	Function	位 (Bit)							
		7	6	5	4	3	2	1	0
0	PIN4 output	Port7	Port6	Port5	Port4	Port3	Port2	Port1	Port0
1	PIN2 output	Port7	Port6	Port5	Port4	Port3	Port2	Port1	Port0

Data description (binary): 0 = off 1 = on

CIE communication protocol---process input data

Bytes	Function	位 (Bit)							
		7	6	5	4	3	2	1	0
0	PIN4 input	Port7	Port6	Port5	Port4	Port3	Port2	Port1	Port0
1	PIN2 input	Port7	Port6	Port5	Port4	Port3	Port2	Port1	Port0
2	PIN4 short circuit status	Port7	Port6	Port5	Port4	Port3	Port2	Port1	Port0
3	PIN2 short circuit status	Port7	Port6	Port5	Port4	Port3	Port2	Port1	Port0
4	Port power short circuit	Port7	Port6	Port5	Port4	Port3	Port2	Port1	Port0
5	Module status				Us over pressure	Ua over pressure	overheat	Us undervoltage	Ua undervoltage

Data description (binary): 0=no signal 1=signal

*When the CIE ECT communication protocol is used, the PIN input and output mode does not need to be configured for self-adaptation

5.3 PLC Integration Tutorial

(Before configuring the module, you should set the module communication protocol, see 5.1.1 for details)

5.3.1 Siemens S7-1200 Portal Integration (PN)

1、Install the GSD file

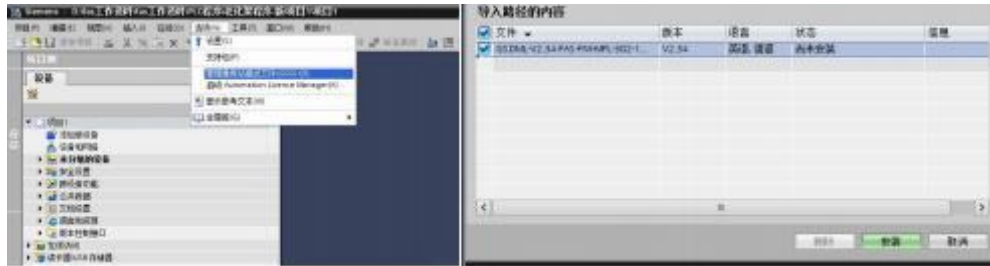

2、 In PLC---Device Configuration---Network View---Hardware Catalog, select the module and drag it in, click "Unassigned", and select the PLC to be connected;

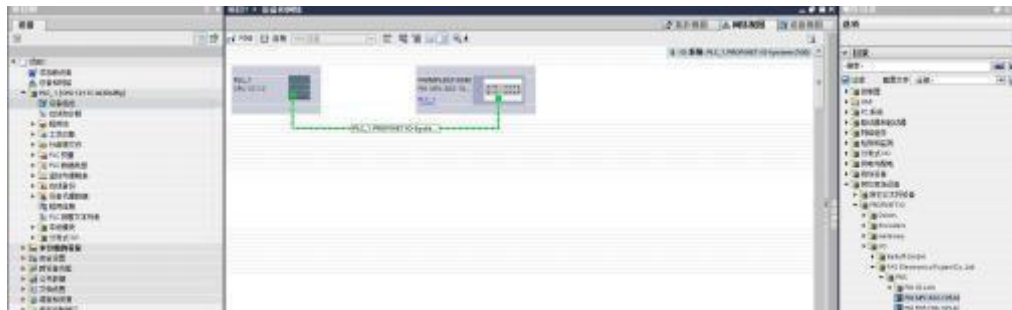

3、 Double-click the module to enter the configuration,

(1) Slot function configuration: in the hardware catalog -- module select the required data and drag it into the slot in the device overview window;

(2) Module port function configuration: Click the module icon, select "General", and then click slot 1 to configure the port function



(3) Module function configuration: Click the module icon, select "General", and then click slot 0 to configure the module function

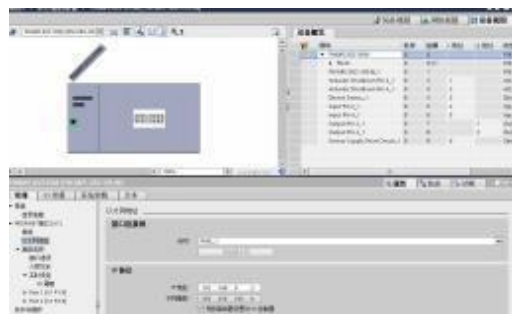

- (4) After the configuration is complete, in the configuration view, click Download.
4. Assign module PN name: PLC switch to online state, select "ungrouped device"---click on the module name---select online and diagnosis---function---assign PROFINET device name--- -Select the module to be assigned in the list (should be selected according to the physical MAC) --- Click "Assign Name" to complete the configuration! .



5.3.2 2 OMRON NX1P2 Sysmac Studio Integrated (EIP)

- 1、 Install the EDS file: Tools---ETHERNET/IP Connection Settings---Double-click PLC in the window---right-click on the blank space of the toolbox on the right and select "Show EDS Library", click "Install" in the pop-up window, and select EDS file installation



- 2、 Create a module: Click "+" in the toolbox window, fill in the module IP address, model name, version, and click "Add" below to complete the module creation;

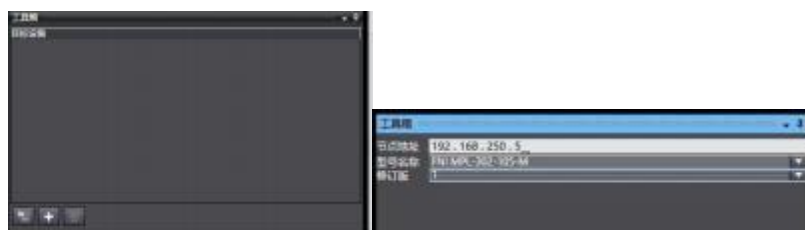

- 3、 Configuration module: Right-click the module--select "Edit"--configure the corresponding values in the parameters according to actual needs, and click OK after completion.

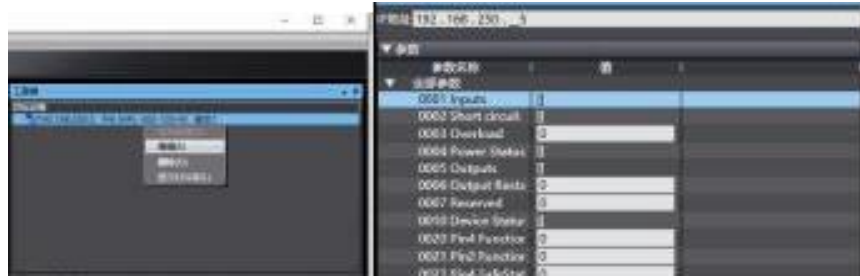

4. Create a variable association:

(1) Programming--Data--Global variables create two arrays, output 2 bytes, input 6 bytes, and the corresponding input and output should be configured in the network disclosure;



(2) In the built-in ETHERNET/IP port setting window--select the first icon (tab) on the left --click "Register All"

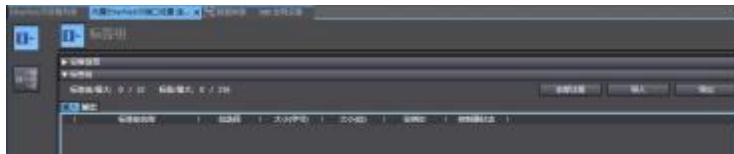

(3) In the built-in ETHERNET/IP port setting window - select the second icon on the left (connection) - click "+", the target device selects the previously configured module, the IO type selects EXCLUSIVE Owner, selects the corresponding input and output, the target The variable must be filled with 101,100; then select the corresponding starting variable, and go online after completion. Select "Transfer to Controller" and the configuration is complete!

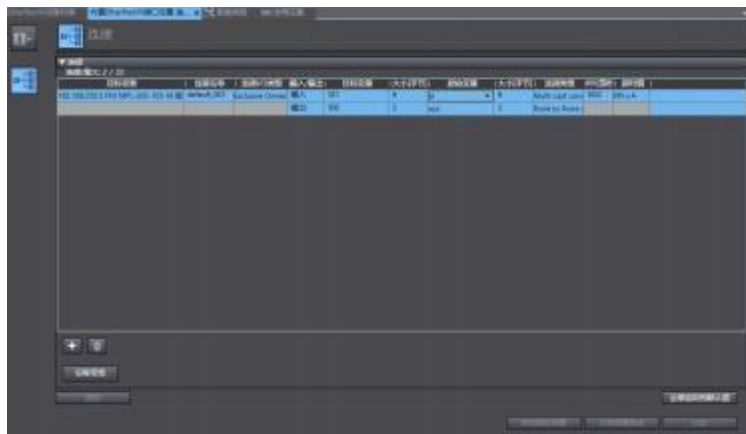

5.3.3 OMRON NX1P2 Sysmac Studio Integrated (ECT)

1、 Install the ESI file: double-click EtherCAT in the configuration and settings--right-click the master device--select "Show ESI library", and select the ESI file in the pop-up window to install

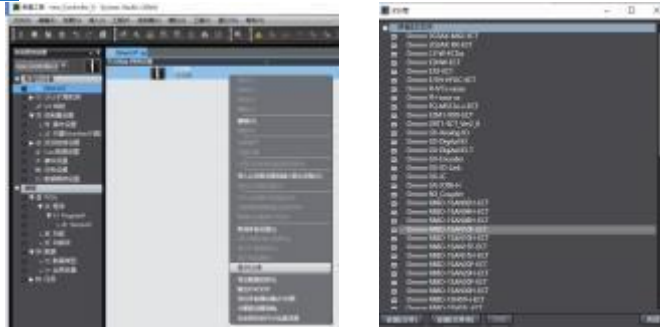

2、 Configure the module to the EtherCAT network: find the FieldBus Modules in the toolbox on the right, find the module model icon and double-click to add it to the network

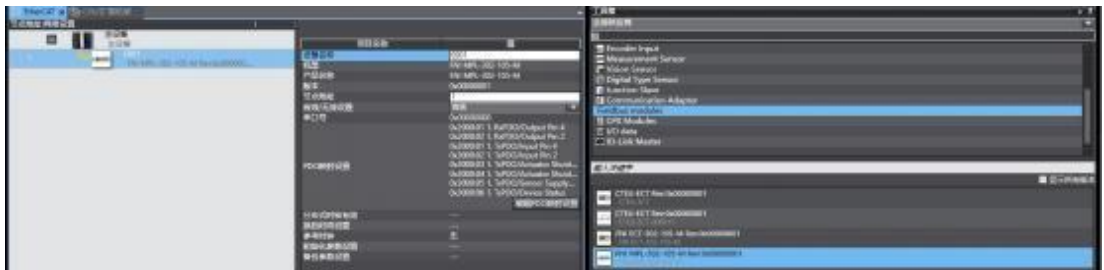

3、 The PLC goes to online mode, right-click the master device, and write the node address of the slave device

4、 Variable mapping: Select the configured node in the I/O mapping, fill in the name of the variable, and the configuration is complete! .



5.3.4 Mitsubishi FX5U Work2 Integrated (CIE)

1. Install the CCSP file: first open GX WORKS 3-Tools-Configuration file management-Login-CSPP file (the project must be closed to import the file)

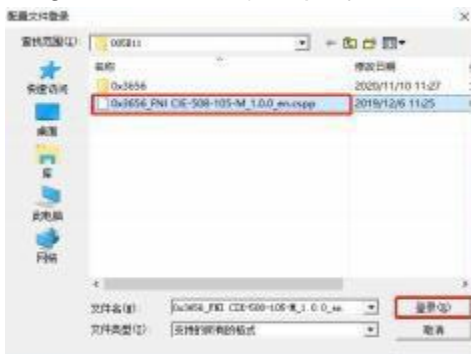

2、 Click on the left project - parameters - FX5UCPU - module parameters - Ethernet port, basic settings - self node settings. Set the own node IP



3. Click CC-Link IEF Basic Settings - select whether to use CC-Link IEF Basic - click to use



4. Click on CC-Link IEF Basic settings - select network configuration settings - detailed settings;



5. Auto-detection of connected devices - takes 4 stations, IP address is set with DIP switch - reflects the setting and closes



6. Refresh target selection specified soft element - soft element name M - assigned soft element address - application, the configuration is complete!

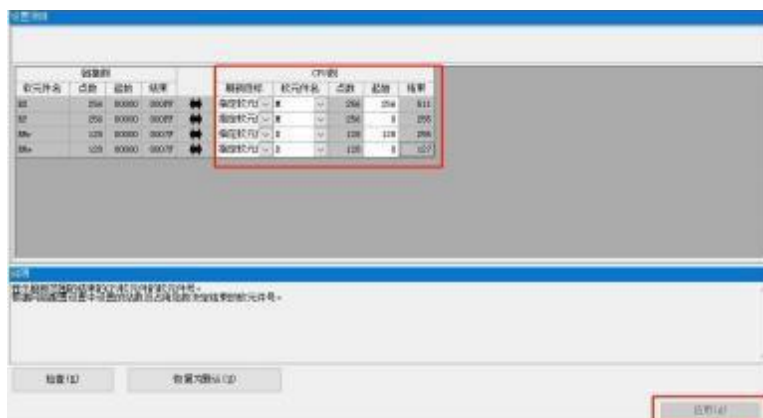

6 Appendix

6.1. Included materials

FNI MPL contains the following components

- I/O- block
- 4 blind plugs M12
- Ground bus
- Thread M4x6
- 20 tags

6.2. Order code

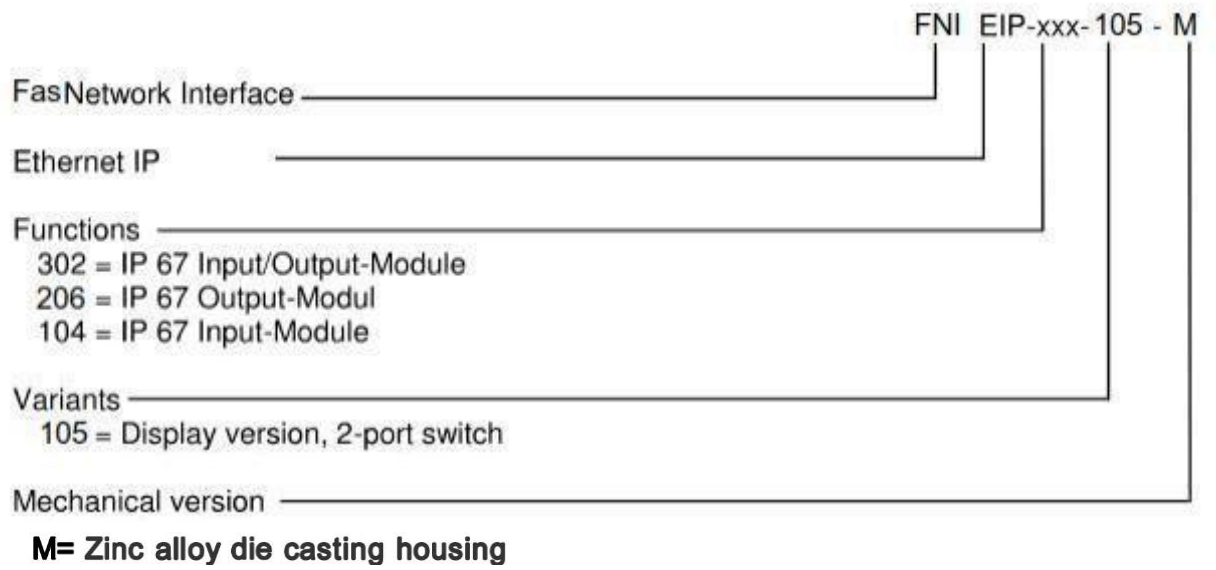

6.3 Ordering Information

Product order code	Order code
FNI MPL-332- 105-M	007E31